

# LED Indoor Luminaires Ceiling Mount – with Emergency Battery 120-277VAC / 60Hz

Model #: BAYL2408LAJUDxx-BB  
BAYL4608LAJUDxx-BB

## Safety Precautions

- Read all safety precautions and installation instructions carefully before installing or servicing this fixture. Failure to comply with these instructions could result in potentially fatal electric shock and/or property damage.
- It is recommended that a qualified electrician perform all the wiring. This fixture must be wired in accordance with all national and local electrical codes.
- Do not handle any energized fixture or attempt to energize any fixture with wet hands or while standing on a wet or damp surface or in water.
- This fixture is designed for use in a 120-277VAC / 60Hz circuit. This fixture is not compatible with dimming circuit.
- Make sure that the power source conforms to the requirements of the fixture. (See labels on the fixture housing).
- To reduce the risk of electrical shock, and to assure proper operation, this fixture must be adequately grounded. To accomplish proper grounding, there must be a separate ground wire (green) contact between this fixture and the ground connection of your main power supply panel.
- This fixture is intended to be used for general indoor lighting in dry or damp locations.
- Disclaimer  
Changes or modifications not expressly approved by the party responsible for compliance could void the user's authority to operate the equipment. NOTE: This equipment has been tested and found to comply with the limits for a Class B digital device, pursuant to Part 15 of the FCC Rules and Canadian ICES-005 (B) / NMB-005 (B). These limits are designed to provide reasonable protection against harmful interference in a residential installation. This equipment generates, uses, and can radiate radio frequency energy and, if not installed and used in accordance with the instructions, may cause harmful interference to radio communications. However, there is no guarantee that interference will not occur in a particular installation. If this equipment does cause harmful interference to radio or television reception, which can be determined by turning the equipment off and on, the user is encouraged to try to correct the interference by one or more of the following measures:
  - Reorient or relocate the receiver antenna.
  - Increase the separation between the equipment and receiver.
  - Connect the equipment into an outlet on a circuit different from that to which the receiver is connected.
  - Consult with the dealer or an experienced radio/TV technician for help.

Any modifications to this fixture may void the warranty and interfere with the safe operation of the luminaire.

Operation is subject to the following two conditions: (1) this device may not cause interference, and (2) this device must accept any interference, including interference that may cause undesired operation of the device.

## Assembly Instructions

### Step 1 – Preparing for installation

- Disconnect electrical power** at the fuse or circuit breaker box before installing or servicing any part of this fixture.
- Carefully remove the fixture from the carton, remove components from hardware kit.
- Remove diffuser (2) from fixture (1) by gently pushing one side up inside top corner and pulling the other side out from the fixture then set it aside until ready to be reinstalled.
- Choose only one of two wiring ports for mounting directly to junction box (not included). Remove the wire cover plate (6) by removing the machine screw (7) if using center of fixture as mounting option. Otherwise, use the other port for power source entry point.
- Align wiring port of fixture (1) to junction box (not included) then using two screws (3) to secure it temporarily to the ceiling. Proceed to mark each location through the four holes on corner of the fixture for additional support. Take fixture down by removing the two screws (3). Drill small pilot hole at center of each marked locations. If there is a wood joist, use a suitable wood screw (4) to mount the fixture. Where there is no wood joist to screw into, drill a larger 1/4" hole for plastic anchor (5) or use a 1/4" toggle bolt (not included) of suitable length to mount fixture securely to the ceiling.
- Proceed to pull supply power source wires from the junction box through wiring port of the fixture (1) while fixture is loose.

### Wiring – All wiring must take place inside junction box (not included)

**Caution:** Make sure power is off at the fuse or circuit breaker box. Check power wires for damage or scrapes. If power supply wires are within three inches of the LED driver, use wire suitable for at least 90°C (194°F). **Note:** Most dwellings built before 1985 have supply wire rated to 60°C. Consult a qualified electrician to ensure correct branch circuit conductor before installing.

### Step 2 – Wiring fixture

- Make all wire connections to appropriate wire. Secure with wire nuts (provided).
- Connect the green wire from the fixture to the supply power source ground wire.
- Connect the white wire from the fixture to the white (N) wire from the supply power source.
- Connect the black wire from the fixture to the black (L) wire from the wall switch On/Off control wire.
- Connect the emergency battery black wire from the fixture to the constant On supply power source.
- Do not mix wires.** Pull on each wire lead to make sure connections are secure. Make certain no bare wires are exposed outside of wire connectors. Tuck all connections neatly into the junction box.

### Step 3 – Mounting

- Install the fixture to the ceiling using hardware as described in accordance with Step E to secure it. Note: Re-install the wire cover plate (6) using machine screw (7) to secure it if mounting to the center of the fixture.

### Step 4 – Color changing temperature adjustment, CCT (if desired)

- Adjust CCT switch inside the fixture according to the desired color temperature of 2700K, 3000K, 3500K, 4000K, or 5000K as shown below. Note: Fixture is preset to 3000K from factory.

### Step 5 – Diffuser

- Install diffuser (2) by gently pushing one side up inside top corner of the fixture in slant position then slowly push the other side up until it is completely inside the fixture then release diffuser as it is securely supported on the flange.

### Step 6 – Restore power at the fuse or circuit breaker box

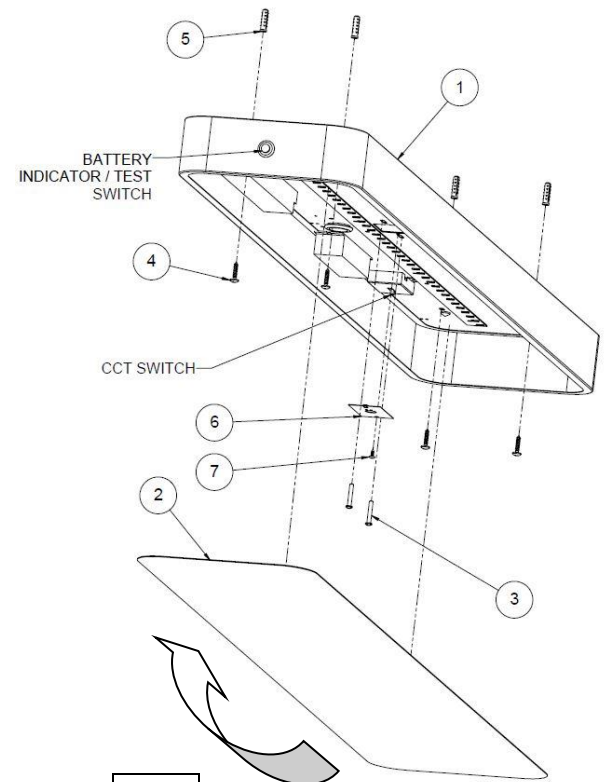











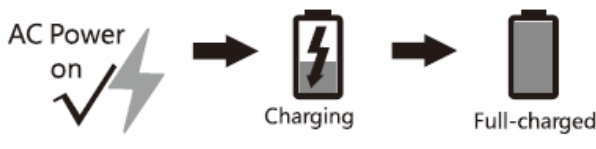
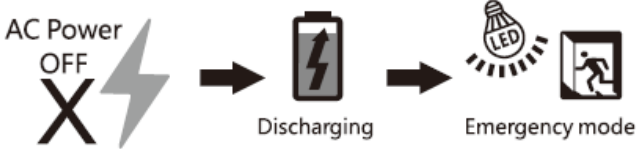





• 2700K
• 3000K
• 3500K
• 4000K
• 5000K

View shown for reference only. Individual models may vary.

### Limited Factory Warranty

AFX Inc. hereby warrants that this fixture is free from defects in materials and workmanship when installed and used under normal operating conditions for a period of 5 years from date of purchase. This warranty covers all component parts and extends only to replacement of defective fixture or components; it does not cover failure due to improper installation, misuse, mishandling or damage incurred in transit.

Emergency Back Up:

<b>Operation</b>							
<p><b>AC Operation:</b>                      AC power is present, The LED load from the LED driver is normal power supply, AC LED driver output current can not exceed 150W or 4A, the emergency driver is charging in a standby mode. The green LED light flashes indicates that it is charging. The green LED light on indicates that it is full charged. After the AC power supply working 48h, The emergency LED drive will automatically from AC power working switch into emergency working mode for 30S every month and then automatically backs to the working mode of the AC power supply, the AC power supply works per year for automatically from the AC power mode backs to the working emergency mode Until the emergency discharge is completed.</p> <p><b>Emergency operation:</b>                      When the AC power goes out ,The emergency driver detects the AC power outage and automatically switch to the emergency mode.</p>							
							
<b>Indicator light introduction</b>	<table border="0" style="width: 100%;"> <tr> <td style="text-align: center; padding: 5px;">                       Green Flashing                      Charging ①                 </td> <td style="text-align: center; padding: 5px;">                       Green ON                      Full-charged ②                 </td> <td style="text-align: center; padding: 5px;">                       Red ON ③                      Discharging(emergency mode)                 </td> </tr> <tr> <td style="text-align: center; padding: 5px;">                       Red Flashing ④                      Discharging(emergency mode) finished soon                 </td> <td style="text-align: center; padding: 5px;">                       Yellow ON ⑤                      Error                 </td> <td></td> </tr> </table>	 Green Flashing Charging ①	 Green ON Full-charged ②	 Red ON ③ Discharging(emergency mode)	 Red Flashing ④ Discharging(emergency mode) finished soon	 Yellow ON ⑤ Error	
 Green Flashing Charging ①	 Green ON Full-charged ②	 Red ON ③ Discharging(emergency mode)					
 Red Flashing ④ Discharging(emergency mode) finished soon	 Yellow ON ⑤ Error						
<b>Test switch introduction</b>	